



SPECIFICATION FOR APPROVAL

File No.: Q/FRK 0.GS.E.C3AG-F03

Product Name	DC-Link-Capacitor (Dry-Type,Plastic case, Temperature 85°C)
Product Type:	C3A(G)
Product Code	
Customer	
Customer Code	
Issue Date	2015-7



Xiamen Faratronic Co. Ltd.

represented by ALFATEC GmbH & Co.KG

**Meckenloher Str. 11
91126 Rednitzhembach / Germany
Tel.: +49 (0) 91 22 / 97 96 -0
Fax.: +49 (0) 91 22 / 97 96 -50
E-mail: info@alfatec.de**

*.The specification are the property of Xiamen Faratronic Co.Ltd and shall not be copied or used as commercial purposes without permission.

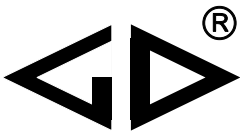

C3A(G)

DC-Link Capacitor (Dry-Type, Plastic case, Temperature 85°C)

■ Outline Drawing

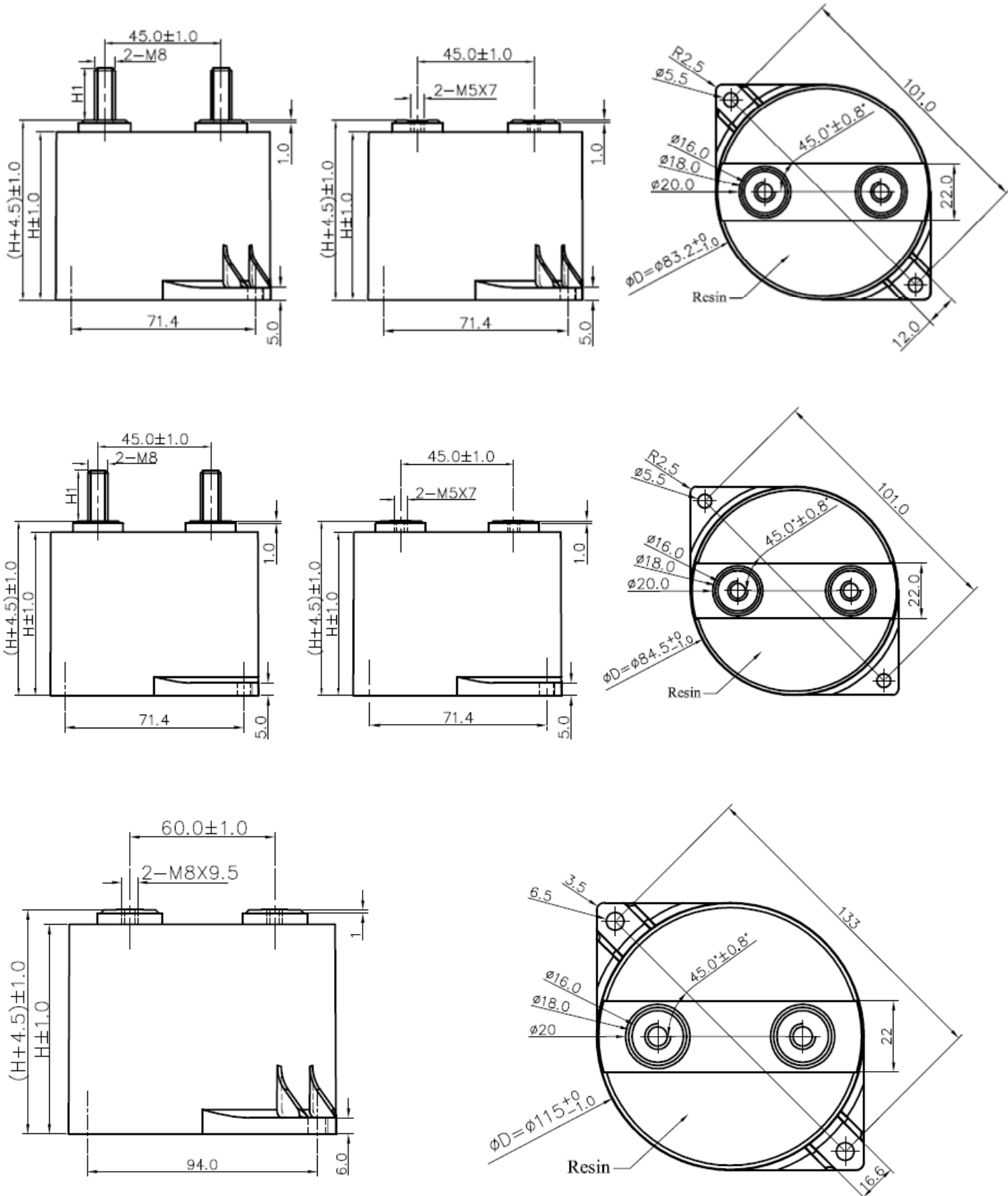



C3A(G)



■ Features

- Used in DC-Link circuits, Can replace electrolytic capacitor
- Low ESR, high ripple current handling capabilities
- Low L_s
- Self-healing property
- Long lifetime
- Plastic case, Filled with resin

■ Applications

- Used in inverters of wind power and solar power
- Welders, Elevators, Motor Driver systems

■ Safety Approvals

	TUV Rheinland	EN 61071:2007, EN 61881-1:2011, 450Vdc~1500Vdc, 10.0μF~600.0μF, -40/85°C Certificate No.: R 50266007
	UL	UL 810(construction only), Max. 5000Vdc, 90°C File No.: E256238, CCN:CZDS2

■ Specifications

Reference Standard	GB/T 17702, IEC 61071	
Climatic Category	40/85/56	
Operating Temperature Range	-40°C~85°C ($\Theta_{hs} \leq 85^\circ\text{C}$)	
Storage Temperature Range	-40°C~85°C	
Voltage Range	600Vdc~1500Vdc	
Capacitance Range	35μF~600μF	
Capacitance Tolerance	±5%(J); ±10%(K)	
Voltage Proof	Between Terminals:	1.5U _N (10s, 20°C±5°C)
	Between Terminals And Case:	3 000Vac (60s, 50Hz, 20°C±5°C)
tgδ _d	0.0002	
IR×C _N	≥5 000s (20°C, 100Vdc, 1min)	
Over Voltage	1.1 U _N (30% of on-load-dur.)	
	1.15 U _N (30min/day)	
	1.2 U _N (5min/day)	
	1.3 U _N (1min/day)	
	1.5 U _N (30ms every time, 1 000times during the life of the capacitor)	
Max. Altitude	2000m	
Max. Torque of terminals	M5: 2.5Nm	M8: 6.0 Nm
Max. Torque of Installation	3.0Nm	
Installation	Any Position	
Failure rate	50 FIT	

Note: The effect of altitude on convection cooling and external insulation should be taken into consideration, if the altitude exceeds 2000m.

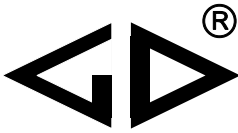

■Part number system

The 18 digits part number is formed as follow:

1	2	3	4	5	6	7	8	9	10	11	12	13	14	15	16	17	18
C	3	A								G							

Digit 1 to 3 Series code

Digit 4 to 5 DC rated voltage

1U=600V 2K=800V 1X=900V 1M=1100V

3L=1200V 2M=1300V 3M=1400V 4M=1500V

Digit 6 to 8 Rated capacitance value

For example: 127=12×10⁷pF=120uF

Digit 9 Capacitance tolerance

J=±5%,K=±10%,

Digit 10 Dimension code

C3A Dimension code		
ΦD	H	Code
84.5	65	1
84.5	50	2
84.5	41	3
83.2	65	4
84.5	76	5
115	64	6

Digit 11 Internal use

Digit 12 to 15 Terminals code

Digit 16 to 18 Internal use

Table 1 Terminals code

Male terminals code

Digit 12		Digit 13		Digit 14		Digit 15	
Code	Terminal form	Code	Fixed style	Code	Length of terminal	Code	Specifications of terminal
2	Male Terminals	B	Double mounting ears in the bottom of the case	0	20mm	0	M8
				1	11mm		
				2	16mm		

Female terminals code

Digit 12		Digit 13		Digit 14		Digit 15	
Code	Terminal form	Code	Fixed style	Code	Depth of terminal	Code	Specifications of terminal
H	Thread hole type	B	Double mounting ears in the bottom of the case	3	7mm	7	M5
				4	9.5mm	1	M8

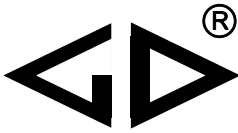

C3A(G)

■ Technical data(mm)

U _N (Vdc)	C _N (μ F)	ESR @10kHz (mΩ)	L _s (nH)	R _{th} (K/W)	Ĥ (A)	I _{max} (A)		Dimension		Weight (kg)	Part number	Expected lifetime
						55°C	65°C	ΦD	H			
600	170	0.8	25	6.8	2 051	74	60	84.5	41	≈0.35	C3A1U177-3G****+++	Lifetime curve
	260	0.9	32	5.3	2 193	79	64	84.5	50	≈0.40	C3A1U267-2G****+++	
	380	1.0	40	5.0	2 135	77	63	84.5	65	≈0.48	C3A1U387-1G****+++	
	380	1.0	40	5.2	2 135	76	62	83.2	65	≈0.47	C3A1U387-4G****+++	
	600	1.1	40	3.4	3 791	89	73	115	64	≈0.90	C3A1U607-6G****+++	
800	100	0.9	25	6.8	2 074	70	57	84.5	41	≈0.35	C3A2K107-3G****+++	
	150	1.0	32	5.3	2 174	75	61	84.5	50	≈0.40	C3A2K157-2G****+++	
	220	1.1	40	5.0	2 123	73	60	84.5	65	≈0.48	C3A2K227-1G****+++	
	220	1.1	40	5.2	2 123	72	59	83.2	65	≈0.47	C3A2K227-4G****+++	
	350	1.3	40	3.4	3 798	82	67	115	64	≈0.90	C3A2K357-6G****+++	
900	100	0.9	25	6.8	2 074	70	57	84.5	41	≈0.35	C3A1X107-3G****+++	
	150	1.0	32	5.3	2 174	75	61	84.5	50	≈0.40	C3A1X157-2G****+++	
	220	1.1	40	5.0	2 123	73	60	84.5	65	≈0.48	C3A1X227-1G****+++	
	220	1.1	40	5.2	2 123	72	59	83.2	65	≈0.47	C3A1X227-4G****+++	
	350	1.3	40	3.4	3 798	82	67	115	64	≈0.90	C3A1X357-6G****+++	
1 100	66	1.2	25	6.8	1 828	60	49	84.5	41	≈0.35	C3A1M666-3G****+++	
	100	1.3	32	5.3	1 936	66	53	84.5	50	≈0.40	C3A1M107-2G****+++	
	140	1.5	40	5.0	1 805	63	51	84.5	65	≈0.48	C3A1M147-1G****+++	
	140	1.5	40	5.2	1 805	62	50	83.2	65	≈0.47	C3A1M147-4G****+++	
	190	1.7	45	4.6	2 003	61	50	84.5	76	≈0.55	C3A1M197-5G****+++	
	150	1.5	45	4.6	1 861	65	53	84.5	76	≈0.55	C3A1M157-5G****+++	
1 300	230	1.4	40	3.4	3 333	79	64	115	64	≈0.90	C3A1M237-6G****+++	
	47	1.3	25	6.8	1 780	58	47	84.5	41	≈0.35	C3A2M476-3G****+++	
	70	1.4	32	5.3	1 853	63	51	84.5	50	≈0.40	C3A2M706-2G****+++	
	100	1.8	40	5.0	1 763	57	47	84.5	65	≈0.48	C3A2M107-1G****+++	
	100	1.8	40	5.2	1 763	56	46	83.2	65	≈0.47	C3A2M107-4G****+++	
	130	1.9	45	4.6	1 874	58	47	84.5	76	≈0.55	C3A2M137-5G****+++	
1 400	160	1.6	40	3.4	3 170	74	60	115	64	≈0.90	C3A2M167-6G****+++	
	40	1.3	25	6.8	1 742	58	47	84.5	41	≈0.35	C3A3M406-3G****+++	
	56	1.5	32	5.3	1 735	61	50	84.5	50	≈0.40	C3A3M566-2G****+++	
	86	1.8	40	5.0	1 743	57	47	84.5	65	≈0.48	C3A3M866-1G****+++	
	86	1.8	40	5.2	1 743	56	46	83.2	65	≈0.47	C3A3M866-4G****+++	
	110	1.9	45	4.6	1 823	58	47	84.5	76	≈0.55	C3A3M117-5G****+++	
1 500	130	1.7	40	3.4	2 961	72	58	115	64	≈0.90	C3A3M137-6G****+++	
	35	1.4	25	6.8	1 198	56	45	84.5	41	≈0.35	C3A4M356-3G****+++	
	50	1.6	32	5.3	1 636	59	48	84.5	50	≈0.40	C3A4M506-2G****+++	
	76	1.9	40	5.0	1 656	56	45	84.5	65	≈0.48	C3A4M766-1G****+++	
	76	1.9	40	5.2	1 656	55	45	83.2	65	≈0.47	C3A4M766-4G****+++	
	95	2.1	45	4.6	1 692	55	45	84.5	76	≈0.55	C3A4M956-5G****+++	
110	1.8	40	3.4	2 693	70	57	115	64	≈0.90	C3A4M117-6G****+++		

Expected lifetime curve

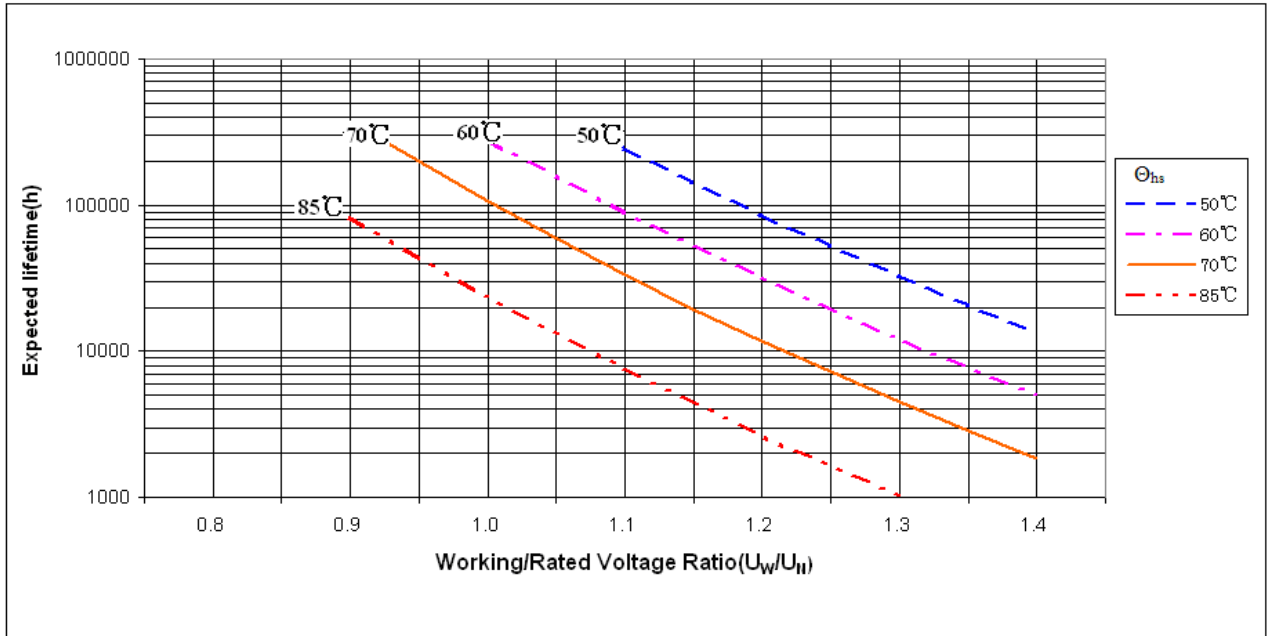

- Note:
1. “-”=capacitance tolerance code, J=±5%,K=±10%
 2. “****”=terminals code(refer to table1),terminals can be male or female.
 3. “+++” =Internal use.
 4. “ I_{max} ”= Maxium r.m.s current at Θ_{amb} . Θ_{hs} will reach the maximum value on this condition.
 5. “ R_{th} ” = R_{th} between hotspot and ambient on natural cooling condition.
 6. The length of terminals H1 available on request (refer to table1).
 7. Other capacitance and dimensions are available on request.
 8. $\Theta_{hs} = \Theta_{amb} + I_{rms}^2 \times ESR \times R_{th}$.